



NIAGARA

**General Catalogue
Catálogo General
Catalogue général**



NIAGARA

FUTURE INTELLIGENT PUMPS



North America:

Head Office, Canada:

- 📍 Address: 4 Laurier Ave, Milton, Postal Code: L9T4V2, Ontario, Canada.
- ☎️ Tel: +1 (514) 550 5578
- ✉️ Email: sales@niagarapumps.ca

USA:

- 📍 Address: 8450 Cambridge street zip code 77054 Houston Texas.
- ☎️ Tel: +1 (713) 363 1585
- ✉️ Email: usa@niagarapumps.ca



Europe:

Sweden:

- 📍 Address: Lisa sass Gatan 12 Gothenburg – Sweden.
- ☎️ Tel: +4 (670) 099 1626
- ✉️ Email: sweden@niagarapumps.ca

Turkey:

- 📍 Address: FATIH MAH URFALILAR CAD, NO 9A, Esenyurt, Istanbul-Turkey.
- ☎️ Tel: +9 (537) 523 9069
- ✉️ Email: turkey@niagarapumps.ca



Middle East:

- 📍 Address: Liwara 1, Shaikh Rashid Bin Humaid St. Ajman, UAE
- ☎️ Tel: +9 (715) 5269 3552
- ✉️ Email: uae@niagarapumps.ca

FB

Three speed circulation pump Bomba circulación tres velocidades Pompe circulation à trois vitesses



DESCRIPTION/DESCRIPCIONES/DESCRIPTION

- Three speed adjustment for water pressurization.
- Ceramic wet rotor motor, low noise.
- No mechanical seal, low failure rate.
- Pump body with anticorrosive electrophoresis.
- Ajuste de tres velocidades para presurización agua.
- Motor de rotor húmedo de cerámica, bajo nivel ruido.
- Sin sello mecánico, baja tasa de fallas.
- Cuerpo bomba con electroforesis anticorrosiva.
- Réglage à trois vitesses pour pressurisation l'eau.
- Moteur à rotor humide en céramique, à faible bruit.
- Pas de joint mécanique, faible taux de défaillance.
- Corps de pompe avec électrophorèse anticorrosion.

APPLICATIONS/APLICACIONES/APPLICATIONS

- As a result of their reliability and the fact that they are easy to use, these pumps are widely used in hot-water service systems like HVAC, air conditioning, hot water circulation system and boiler hot water, domestic water pressure and other fields.
- Como resultado de su confiabilidad y el hecho de que son fáciles de usar, estas bombas son ampliamente utilizadas en sistemas de servicios de agua caliente como HVAC, aire acondicionado y agua caliente de caldera, doméstico presión de agua y otros campos.
- En raison de leur fiabilité et de leur facilité d'utilisation, ces pompes sont largement utilisées dans les systèmes de service d'eau chaude tels que HVAC, climatisation et eau chaude de chaudière, domestique la pression de l'eau et d'autres champs.

MATERIAL DESCRIPTION/DESCRIPCIÓN DE MATERIAL/DESCRIPTION DU MATÉRIEL

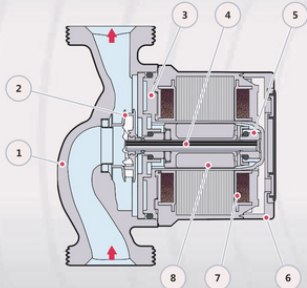

No.	Description Descripción Description	Material Material Matériel
1	Pump Case Cuerpo de Bomba Boîtier de pompe	Cast iron Fundición Fonte
2	Impeller Impulsor Roue	Plastic Plástico Plastique
3	Shielding Blindaje Blindage	SS304 Inox 304 Inox 304
4	Shaft Eje Arbre	Ceramic Cerámico Céramique
5	Bearing Rodamiento Palier	Ceramic Cerámico Céramique
6	Motor Case Cuerpo de Motor Boîtier du moteur	Aluminum Aluminio Aluminium
7	Stator Estator Stator	Silicon steel/Copper Acero silicio/Cobre Acier silicium/Cuivre
8	Rotor Rotor Rotor	SS304 Inox 304 Inox 304

NIAGARA

TECHNICAL DATA/DATOS TÉCNICOS/DONNÉES TECHNIQUES

MODEL MODELO MODÈLE	Power W	Voltage V	Max flow m³/h	Max Head m	DN mm	h mm	a1 mm	a2 mm	b1 mm	b2 mm
FB15-4-130	72/53/38	220V	1.8/1.4/1	4.5/4/3	20 to 15	130	77	51	25	105
FB20-4-130	72/53/38	220V	2/1.5/1	4.5/4/3	25 to 20	130	77	51	25	105
FB25-4-130	72/53/38	220V	2.5/2/1.5	4.5/4/3	40 to 25	130	77	51	25	105
FB25-4-180	72/53/38	220V	3/2/1.5	4.5/4/3	40 to 25	180	77	51	25	105
FB32-4-130	72/53/38	220V	3/2/1.5	4.5/4/3	50 to 32	130	77	51	25	105
FB32-4-180	72/53/38	220V	3.5/2.5/1.6	4.5/4/3	50 to 32	180	77	51	25	105
FB15-6-130	93/67/46	220V	2/1.5/1	6/5/3	20 to 15	130	77	51	25	105
FB20-6-130	93/67/46	220V	2.5/2/1.5	6/5/3	25 to 20	130	77	51	25	105
FB25-6-130	93/67/46	220V	3.3/2.3/1.6	6/5/3	40 to 25	130	77	51	25	105
FB25-6-180	93/67/46	220V	3.5/2.5/1.6	6/5/3	40 to 25	180	77	51	25	105
FB32-6-130	93/67/46	220V	3.5/2.5/1.6	6/5/3	50 to 32	130	77	51	25	105
FB32-6-180	93/67/46	220V	4.3/3/2	6/5/3	50 to 32	180	77	51	25	105
FB25-7-180	140/95/60	220V	4.8/3.2/1.8	7/6/4.4	40 to 25	180	77	51	39	135
FB32-7-180	140/95/60	220V	4.8/3.2/1.8	7/6/4.4	50 to 32	180	77	51	39	135
FB25-8-180	245/200/135	220V	8/5/3	8/6/4	40 to 25	180	85	51	43	137
FB32-8-180	245/200/135	220V	10/6/3.5	8/6/4	50 to 32	180	85	51	43	137
FB20-12-180	245/220/145	220V	3.1/1.9/1.3	12/11/7	25 to 20	180	85	58	21	134
FB25-12-180	245/220/145	220V	3.7/2.2/1.3	12/11/7	40 to 25	180	85	58	21	134
FB25-15-180	270/210/150	220V	4.1/2.8/1.7	14/13/10	40 to 25	180	85	65	26	151

DIMENSIONS AND WEIGHT/DIMENSIONES Y PESOS/DIMENSIONS ET POIDS

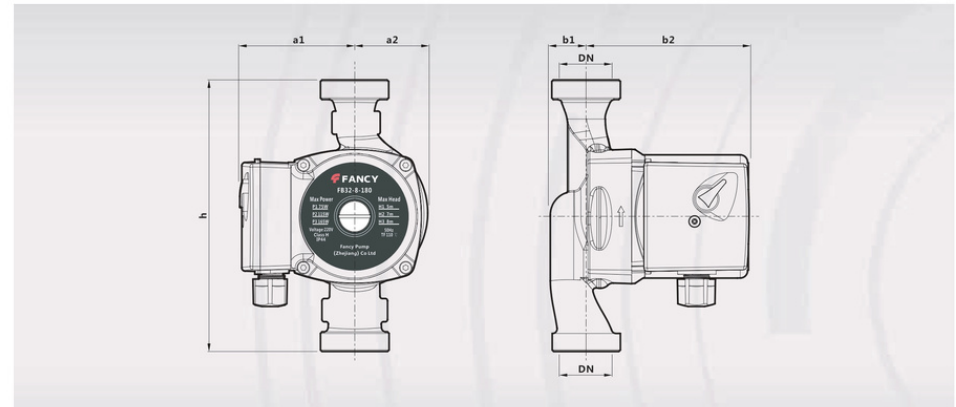

FB

PERFORMANCE CURVE/CURVA DE RENDIMIENTO/COURBE DE PERFORMANCE

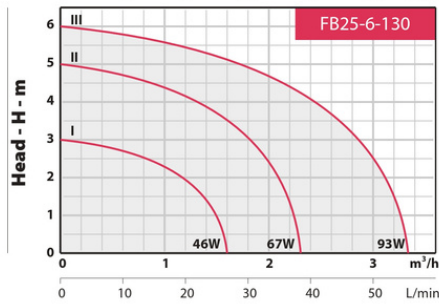
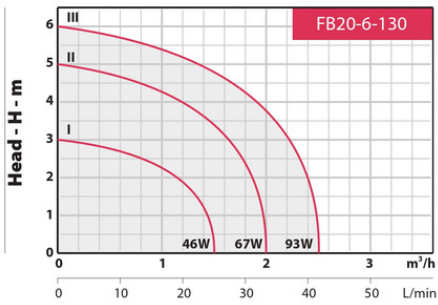
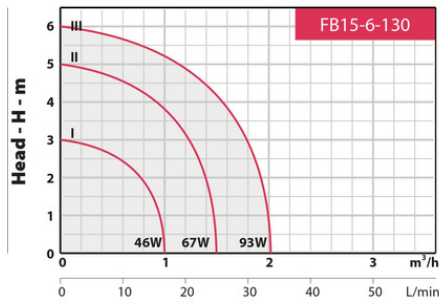
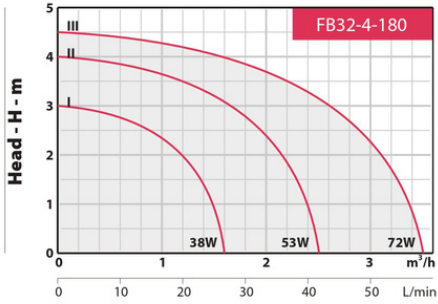
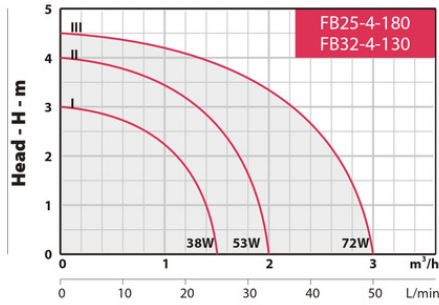
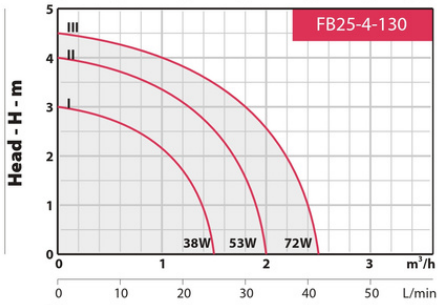
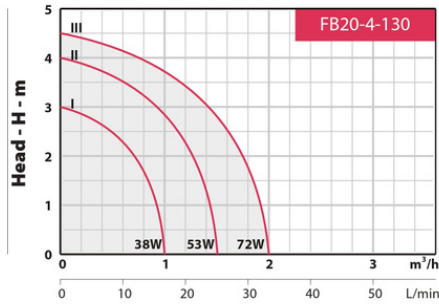
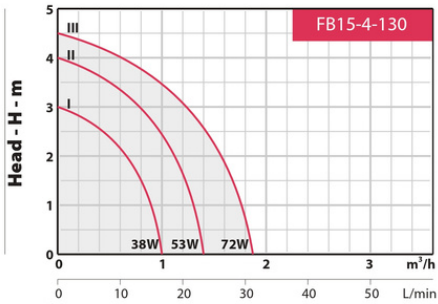
**NIAGARA**

PERFORMANCE CURVE/CURVA DE RENDIMIENTO/COURBE DE PERFORMANCE

